

Length: 48"  
Width: 36"

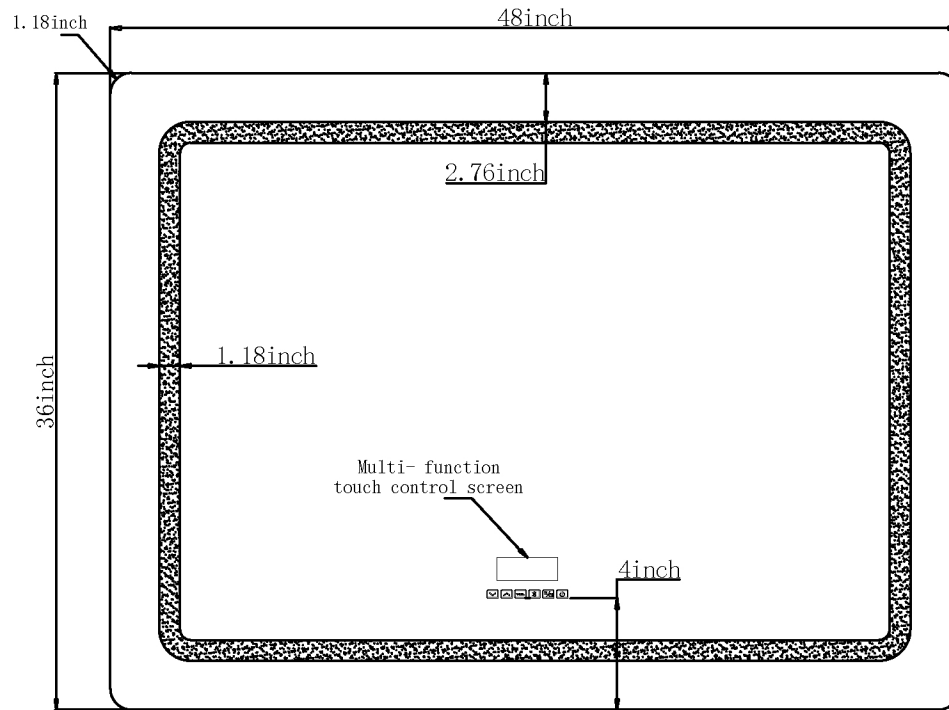

Front View

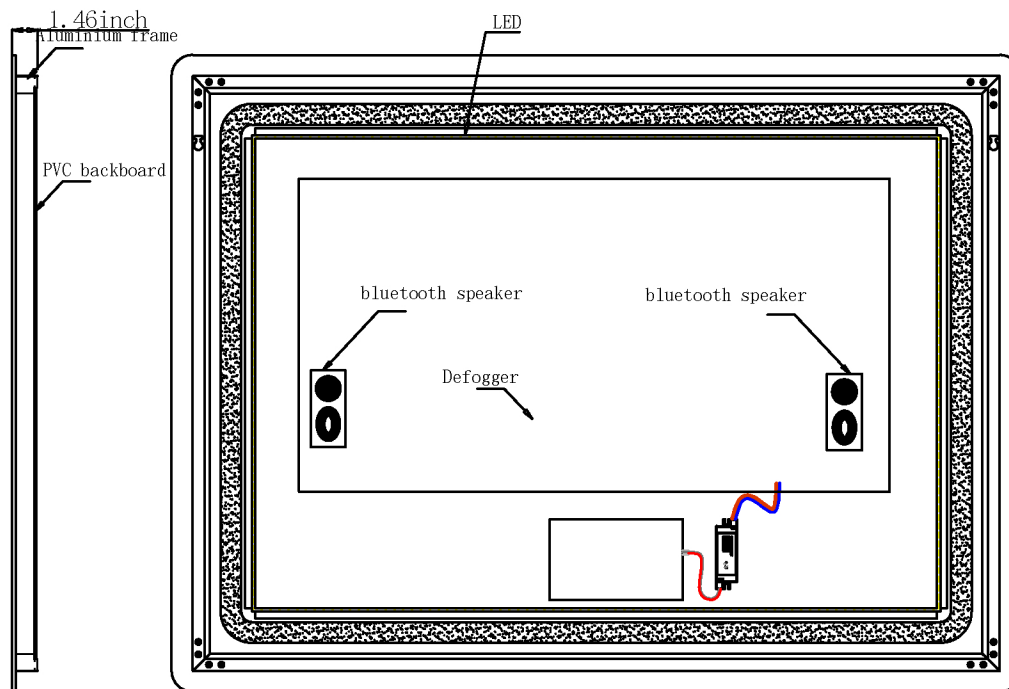

Side View





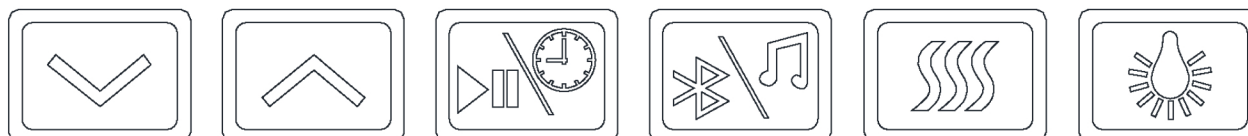

Back View

# LEXORA

## OPERATING INSTRUCTIONS

Button:



-  Touch this button in order to turn the lighting ON/OFF.  
Touch and hold this button in order to dim the light intensity.
-  Touch this button in order to turn the defogger ON/OFF
-  Touch this button in order to turn the Bluetooth speaker ON/OFF.
-  Using a short touch this button controls Play and Pause functionalities.  
Press and hold this button to engage the clock's program mode. In program mode, the clock will go through all 4 number fields with a 3 second break in between. To set the time, press the button again while the number field is flashing.
-  Touch this button to play next song.  
Touch this button and hold for 3 second to make the volume higher.
-  Touch this button to play next song.  
Touch this button and hold for 3 second to lower the volume.

Aftercare Instructions:

- Clean using a soft dry cloth only when turned off
- Never use harsh cleaning agents, chemicals or abrasive materials
- Do not allow moisture or solutions of any kind to stay on the mirror surface or light strips, clean immediately



## LED Bathroom Mirror Caldona Collection

### Product Features:

Copper-free Silver Mirror

Dimmable LED light

Defogger (optional)

Bluetooth speakers (optional)

Clock (optional)

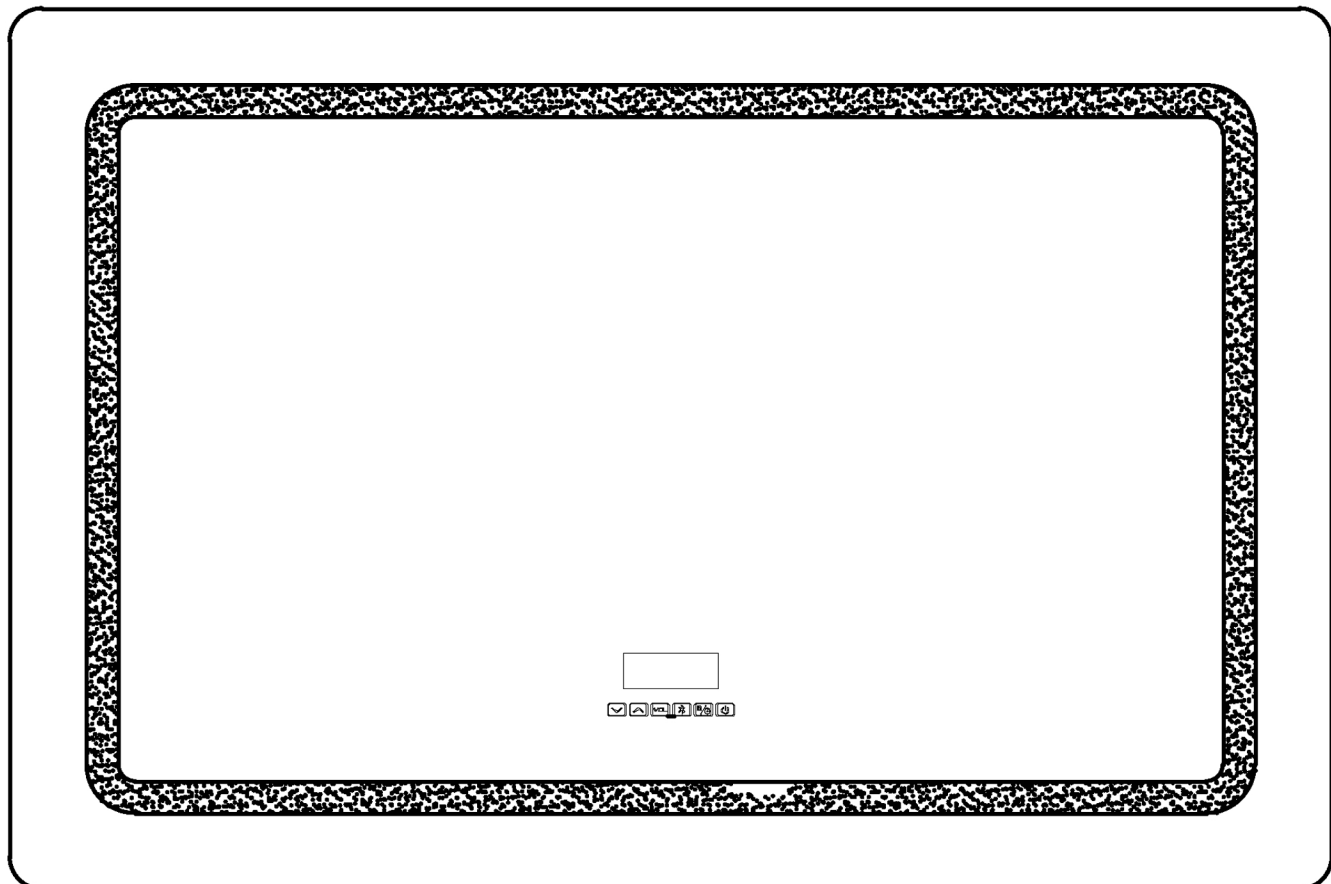

# LEXORA

## HARDWIRE INSTRUCTIONS

**Warning: Manufacturer's warranty shall be void if product is not installed by a licensed professional.**

Prior to commencing installation, please ensure the following:

- the wall where the product is being installed is able to support the weight of the product
- the main electrical supply has been powered off to complete installation

- Green = GROUND wire. connect to the ground wire in your box, or to the box as a ground.
- White = LIVE wire. connect to the White LIVE wire in your box.
- Black = Neutral wire. connect to the Black Neutral wire in your box.

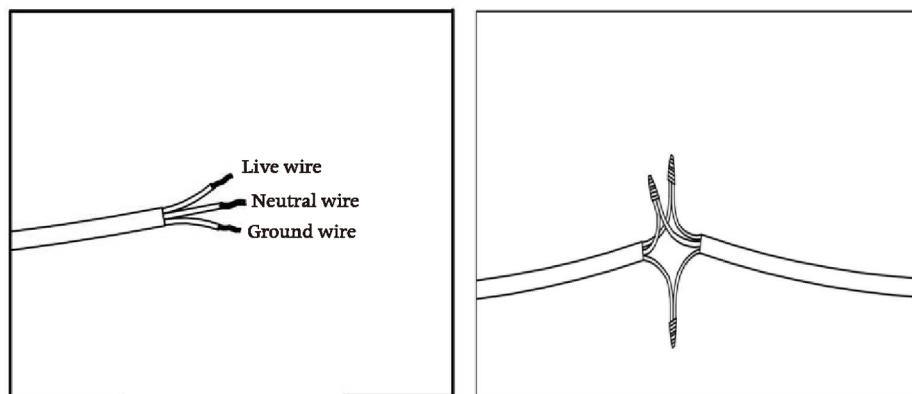

- (1) Match the three wires from the mirror to the main supply.
- (2) Safely connect these three wires one by one .

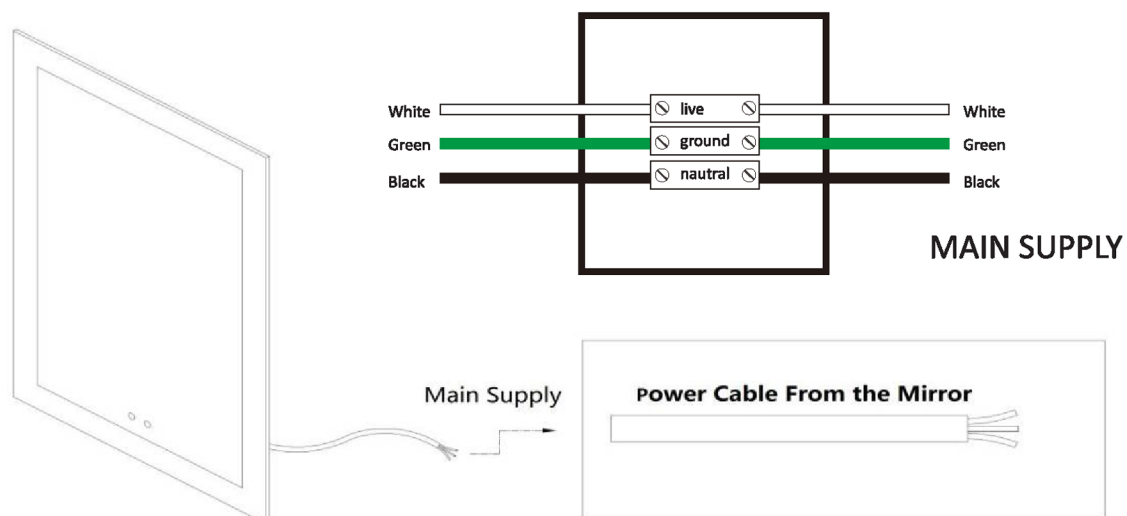



## INSTALLATION INSTRUCTIONS

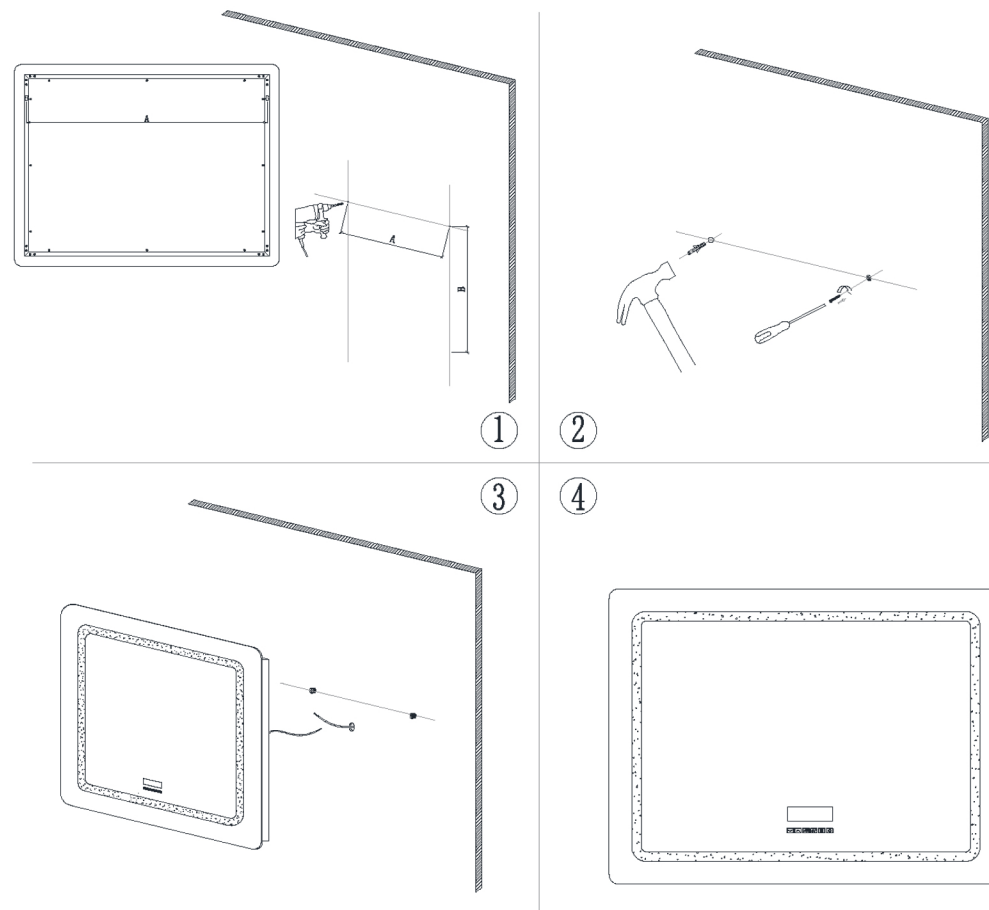

**Warning: Manufacturer's warranty shall be void if product is not installed by a licensed professional.**

- Prior to commencing installation, please ensure the following:
  - the wall where the product is being installed is able to support the weight of the product
  - the main electrical supply has been powered off to complete installation
- Steps for Installation:
  1. Decide on a leveled mounting position and mark the holes
  2. Drill the holes and insert anchors
  3. Insert the dowels into the anchors
  4. Hang the mirror on the mounting panel
  5. Remove the front protective film before use