

LEXORA

Exterior Size: 67" L x 31 1/2" W x 23 1/2" H
Interior Size: 47 1/4" L x 19 3/4" W x 17 3/4" H
Depth at drain: 17 3/4"
Drain to overflow: 13 3/4"
Maximum fill: 72 Gallons
Note: All Measurements are $\pm 1/2"$

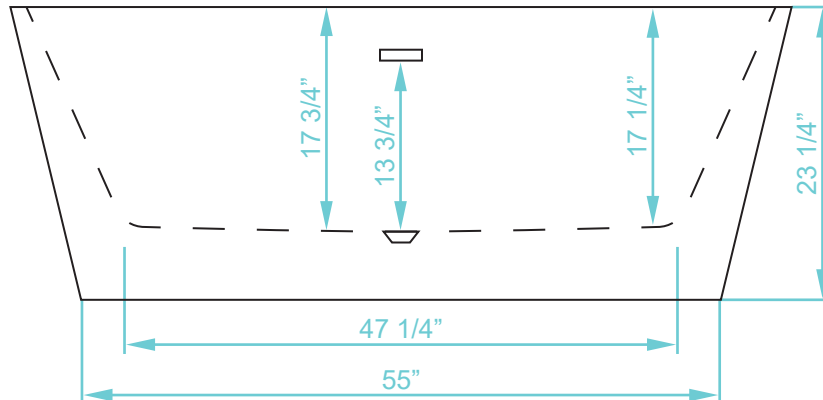
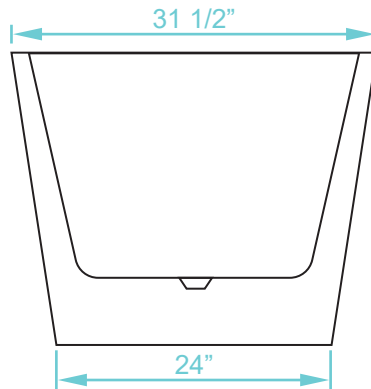
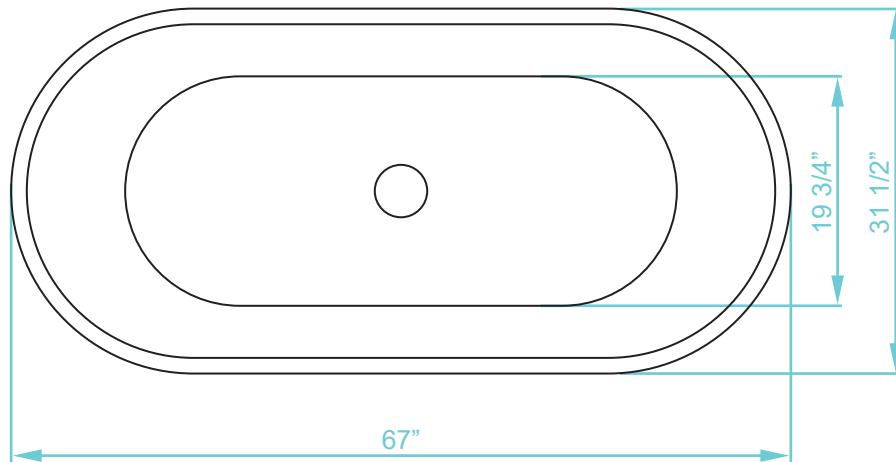

FREESTANDING BATHTUB INSTALLATION AND MAINTENANCE

Note: If you purchased a brushed nickel trim kit, it must be installed before installing the bathtub (brushed nickel trim not available on all models).

Warning: Due to the rough handling during shipping or on the job site, do not install this product until a thorough inspection and water test has been completed.

Check bathtub for correct model and size. Carefully inspect the tub for any damage (i.e. chips, scratches, cracks). If at any point during the pre-installation inspection and water test, you discover a problem with the bathtub or piping system, do not install the unit and contact us immediately.

All preinstalled parts must be checked and retightened before installation.

INSTALL BATHTUB

1. Clean, level, and prepare the floor for installation.
2. Determine the location of the drain pipe on the floor by taking measurements of the drain and waste location beneath the unit.
3. Place the bathtub in the designated space ensuring that the drain and waste locations match with that of the tub and adjust the balancing feet as needed, using a level.

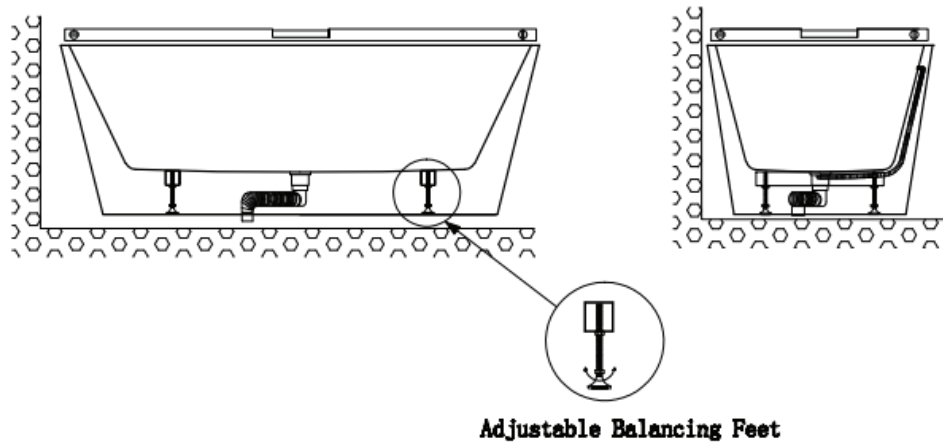

(figure 1)

4. After adjusting the balance of the bathtub with a level, use white/clear silicone around the tub base to complete installation.

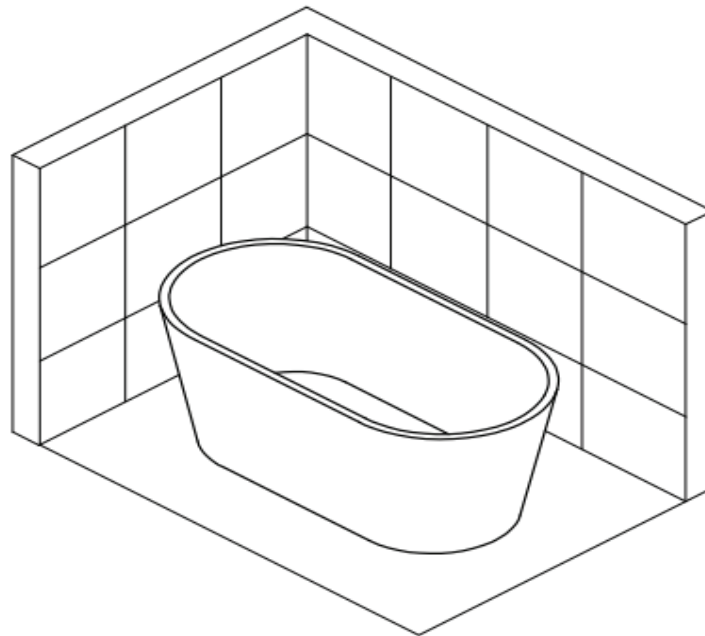

(figure 2)

CLEANING AND MAINTENANCE

1. The bathtub is usually cleaned with general liquid detergent and soft cloth, do not use the detergent that contains acetone or ammonia water element. When you disinfect the bathtub, please use disinfectant without formaldehyde
2. Surface stain can be rubbed with toothpaste on soft cloth.
3. For the mild abrasions or burns on the surface, you can use wet No.2000 waterproof abrasive paper to polish this area, then buffing the ground where it is polished
4. Wipe the dirt on the electroplating parts with a soft cloth. Do not use coarse cloth or thinner to wipe it.
5. It is strictly forbidden to strike the bathtub with sharp hard objects.